

imc CANSASfit UTI-6

6-channel CAN-based measurement module for voltage, current, temperature (RTD) and resistance (NTC)

The UTI-6 module belonging to the imc CANSASfit series is a 6-channel measurement amplifier which captures analog physical measurement variables, digitizes them and outputs the data via CAN-bus.

Individually isolated, configurable differential channels capturing:

- Voltage (25 mV to 60 V)
- Current (20 mA sensors)
- Temperature (PT100, PT1000)
- Resistance (e.g. NTC)



CANFT/UTI-6-SUP
(Fig. similar)

Highlights

- Per-channel isolated measurement inputs, individual filtering and ADCs
- Sensor supply (e.g. for active voltage-fed sensors), individually isolated and adjustable
- 400 Hz bandwidth at max. 1 kSps/channel sampling rate (CAN output rate)
- Measurement ranges and sampling rates individually selectable (in steps of 1, 2, 5)
- 24-bit digitization and internal processing
CAN-output format selectable: 16-bit or FLOAT (24-bit mantissa)

- High temperature durability
Operating temperature: -40°C to +125°C
- Sealed against dust and moisture as per IP65
- Robust, compact and miniaturized
- Click mechanism providing both mechanical and electrical coupling

Typical applications

Robust test measurement for mobile applications at high temperatures and in rugged environments. Particularly on-board vehicles such as in drive tests, under the engine hood.

- General voltage signals, including vehicle battery voltage (up to 60 V) and current measurements at external shunts (down to 25 mV)
- Active voltage-fed sensors
- Industrial sensors (20 mA) for arbitrary physical variables
- Temperature measurement with resistance-based sensors (PTxx, NTC)

imc CANSASfit general functionalities and specifications

As a CAN-Bus-based test and measurement tool, the imc CANSASfit series offers a selection of measurement modules which precondition and digitize sensor signals and output these as CAN-messages. Their design, the resistance to extreme environmental conditions and the supported sensors and signals make them particularly suited for applications in the fields of automotive engineering, vehicle testing, road trials and measurements on mobile machines.

imc CANSASfit modules can be mechanically and electrically attached to each other by means of a click mechanism. When the module connectors are open, this is accomplished without the need for tools and without additional connecting cables.

Application fields

- Ideal for vehicle testing and road trials
- Deployable in both distributed installations and centralized measurement setups
- Operable with CAN interfaces and CAN data loggers from either imc or third-party suppliers

Properties and capabilities

Operating conditions:

- Operating temperature: -40°C to +125°C, condensation allowed
- Ingress protection rating: IP65
- Pollution degree (internally): 2; according to IEC 61010-1:2010
- Shock resistance in accordance with MIL STD810F

CAN-Bus:

- Configurable Baud-rate (max. 1 Mbit/s)
- Default configuration ex-factory: Baud rate=500 kbit/s and IDs: Master=2, Slave=3
- Galvanically isolated

Sampling rates and synchronization:

- Configurable CAN data rate
- Simultaneous sampling of all module's channels

Power supply:

- Wide range supply voltage, see [technical specs](#) 
- LEMO.0B.305 sockets (IN / OUT) in conjunction with CAN-Bus signals

Onboard signal processing (depending on module type):

- Low pass filter
- Anti-Aliasing Filter (AAF) automatically adapted to the output rate
- Averaging filter
- Multi functional status LED, global or channel-wise (depending on module type)

Heartbeat-message:

- Configurable with cyclical "life-sign", e.g. for integrity check purposes in test rigs
- Contains checksum for configuration and serial number, e.g. for consistency monitoring (checking of whether the correct module is still being used, for instance in installations undergoing maintenance)

fit-series: versatile, click-together module block assemblies

Click mechanism:

- Multiple modules connected in a central block: mechanically and electrically (CAN and power supply)
- No need for tools or additional connection cables
- To maintain the degree of protection, the assembly of a complete system consisting of several modules must be carried out in a controlled environment (e.g. also sealing cap for click connectors).

Mounting options:

- Fastening eyelets provided for installation with cable ties, screws or bolts



imc CANSASfit modules connected in a block
(click mechanism)



Latching mechanism and
protective cover for click mechanism

Software

Configuration:

- Using imc CANSAS software (free of charge), including dbc-export
- Autostart with saved configuration; also pre-configurable at factory

Measurement operation:

- Data logger operation:
 - Software: imc STUDIO
 - Hardware: imc ARGUSfit
 - imc measurement system with CAN-Interface, e.g.
 - imc BUSDAQ, imc C-SERIES, imc SPARTAN
 - imc CRONOS device family (CRFX, CRC, CRXT, CRSL)
- With any desired CAN-interfaces and CAN-loggers from 3rd-party suppliers

Available variants of imc CANSASfit UTI-6

Order Code	Signal connection	CAN connection	Option/extra	article no.
CANFT/UTI-6-SUP	LEMO.1B.307	LEMO.0B.305	sensor supply (bipolar)	12100002
CANFT/UTI-6-TEDS	LEMO.1B.307	LEMO.0B.305	with TEDS and sensor supply (unipolar)	12100035

Mechanical drawings with dimensions

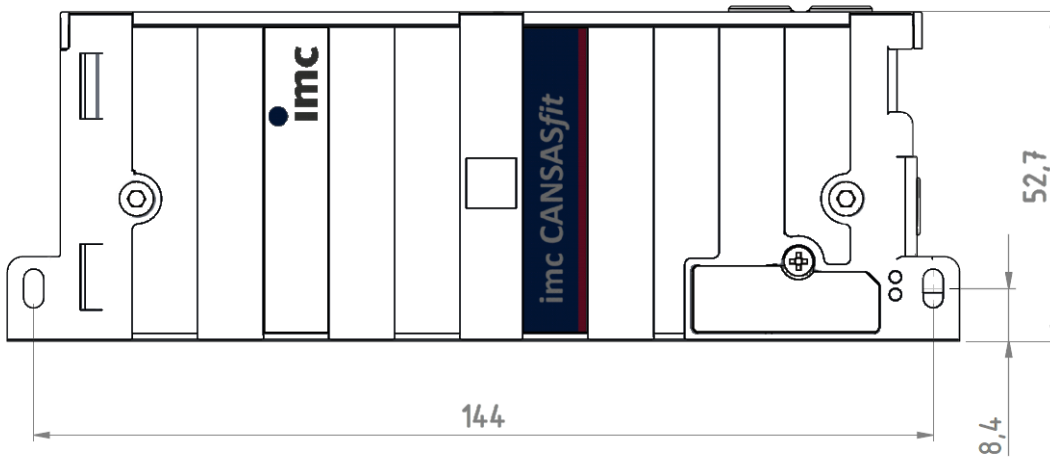

Module shown in standard operating position (terminal connections upwards)

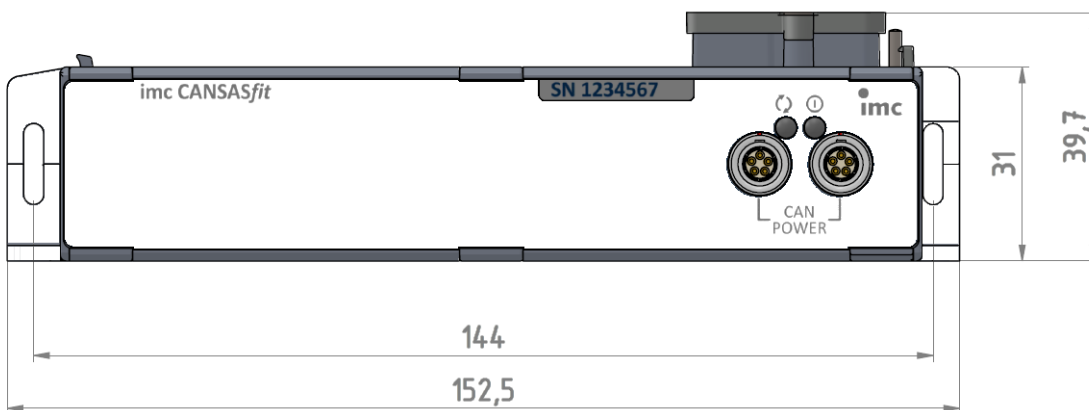

Included accessories

Documents	
Getting started with imc CANSASfit (one copy per delivery)	
Device certificate	
Miscellaneous	
6x ACC/CAP-LEMO.1B, 13500233 (protective cover for LEMO.1B sockets)	
2x ACC/CAP-LEMO.0B, 13500232 (protective cover for LEMO.0B sockets)	

Optional accessories

Power supply: AC/DC power adaptor (imc CANSASfit power set)		
CANFT/POWER-P	AC/DC power adaptor, 24 V DC, 60 W, PHOENIX, cable for CAN and power supply, LEMO.0B to DSUB-9, power supply via PHOENIX	12100023

Connector: signals		
ACC/FGG.1B.307.CLAD62ZN	plug for the signal connection (FGG series ¹)	13500096
ACC/FEG.1B.307.CLAD62ZN	plug for the signal connection (FEG series ¹), IP54	13500262
ACC/GMF.1B.062.072.EN	protective IP65 cover for the LEMO 1B plug (FGG series)	13500098

CAN: cable ¹ and connector		
ACC/FGG.0B.305.CLAD56ZN	plug for the CAN connection (FGG series ²)	13500245
ACC/GMF.0B.035.060.EN	protective IP65 cover for LEMO 0B plug (FGG series ²)	13500272
ACC/CABLE-LEMO-LEMO-2M5	CAN + Power cable 2x LEMO.0B 2.5 m	13500229
ACC/CABLE-LEMO-DSUB-2M5	CAN + Power cable LEMO.0B/DSUB 2.5 m	13500230
ACC/CABLE-LEMO-DSUB-BAN-2M5	CAN + Power cable LEMO.0B/DSUB/PWR power supply via banana, 2.5 m	13500231
ACC/CABLE-LEMO-DSUB-LEMO-1B	CAN + Power cable LEMO.0B/DSUB power supply via LEMO.1B.302 for the 15V/24V power adaptor (e.g. CRPL/AC-ADAPTER-60W): G-coded	13500368
ACC/CABLE-LEMO-DSUB-LEMO-1BE	CAN + Power cable LEMO.0B/DSUB power supply via LEMO.1B.302 for 48 V power adaptor (ACC/AC-ADAP-48-150-1B): E-coded	13500296
ACC/CABLE-LEMO-LEMO-PWR-0M5	CAN + Power cable 2xLEMO.0B 0.5 m, with power supply for separate segments via banana jacks	13500324
ACC/CAP-LEMO.0B	protective IP65 cover for the LEMO 0B socket	13500232
ACC/CAP-LEMO.1B	protective IP65 cover for the LEMO 1B socket	13500233
ACC/CANFT-TERMI	CAN Terminator 120 Ω, LEMO.0B plug	13500242
ACC/CANFT-RESET	CAN Reset plug, manual reset via click connector	13500421

Mounting accessories		
CANFT/BRACKET-DIN	Mounting on DIN-Rail (top hat rail) imc CANSASfit	12100029
CANFT/BRACKET-MAG	Mounting with magnet system for imc CANSASfit	12100030

imc CANSASfit configuration package (USB)		
CANFT/USB-P		12100018
USB-CAN interface (CAN: DSUB-9, USB 2.0); AC/DC power adaptor, 24 V DC, 60 W, connection via PHOENIX; CAN and power cable LEMO.0B/DSUB Power supply via PHOENIX, 2.5 m; CAN Terminator 120 Ω, LEMO.0B; gender changer (DSUB-9) with integrated CAN terminator; imc CANSAS configuration software (download), including COM library and LabVIEW (TM) VI		

To maintain the degree of protection, the assembly of a complete system consisting of several modules must be carried out in a controlled environment (e.g. also sealing cap for click connectors). Further detailed instructions for handling can be found in "Getting Started" and in the manual for imc CANSAS modules.

- 1 other cable lengths available
- 2 The LEMO plug series FGG and the FEG series are both compatible with the module's terminals.
The FEG plug model has an additional sealing lip which ensures an IP54 grade seal when connected. The protection rating provided by the FGG model when connected is IP50. The measurement module's protection rating remains at IP65. The FGG plug could additionally be equipped with a protection grommet (e.g. 13500098) to achieve the protection rating IP65 when connected.

Documents		
SERV/CAL-PROT	Calibration protocol per amplifier imc manufacturer calibration certificate with measurement values and list of calibration equipment used (pdf).	150000566
SERV/CAL-PROT-PAPER	Calibration protocol per amplifier (paper print) imc manufacturer calibration certificate with measurement values and list of calibration equipment used with signature and seal.	150000578
Device certificates and calibration protocols: Detailed information on certificates supplied, the specific contents, underlying standards (e.g. ISO 9001 / ISO 17025) and available media (pdf etc.) can be found on our website, or you can contact us directly.		

Technical Specs - CANFT/UTI-6

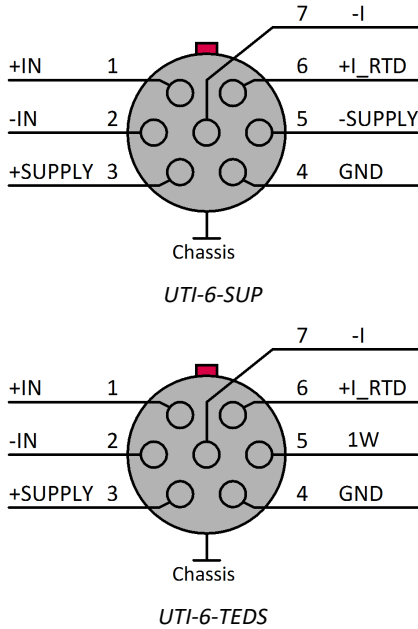
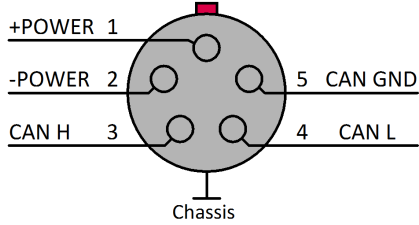

General

Inputs, measurement mode			
Parameter	Value typ.	min. / max.	Remarks
Inputs	6		
Measurement mode	voltage measurement current measurement resistance measurement temperature measurement PT100/PT1000		4-wire
Connector / socket CAN / power supply Measuring input LEMO pin configuration	compatible socket type LEMO.0B 5-pin LEMO.1B 7-pin measuring input		recommended plug FEG.0B.305 FEG.1B.307 CAN / power supply
	 <p>Chassis <i>UTI-6-SUP</i></p> <p>Chassis <i>UTI-6-TEDS</i></p>	 <p>Chassis</p>	
Module connector	Click-connection (covering caps)		for the supply and system bus (CAN) of directly connected modules without further cables
TUID Transducer Unique Identifier	similar to IEEE 1451.1 TEDS		with CANFT/UTI-6-TEDS; read only single wire interface: 1W

Sampling rate, Bandwidth, Filter			
Parameter	Value typ.	min. / max.	Remarks
Sampling rate		≤1 kHz	CAN output rate of the CAN-Bus data, individually per channel
Bandwidth	0 Hz to 400 Hz		CAN output rate: 1 kHz, AAF Filter
Filter			
Type	low pass		individual selectable; mean and AAF: adapted automatically, according to selected output rate
Characteristic	Butterworth, Bessel, averaging filter (sinc), AAF		
Cut-off frequency	1 Hz to 200 Hz		
Order	2 nd and 8 th		
Anti-aliasing filter	Cauer 8 th order with $f_{\text{cut-off}} = 0.4 \cdot f_s$		
Resolution	24 Bit		output: 32 Bit Float or 16 Bit Integer

Isolation		
Parameter	Value	Remarks
Isolation		against housing
CAN-Bus	±60 V	test voltage: ±300 V (10 s)
power supply input	±60 V	test voltage: ±300 V (10 s)
Analog input channels	±60 V	analog input and sensor supply
Channel-to-channel	±60 V	

Coupling		
Parameter	Value	Remarks
Input coupling	DC	
Input configuration	isolated	

Status-LED			
Parameter		Value	Remarks
Power-LED green red		bicolor power active reverse polarity fault	
Status-LED green blue yellow red		multicolor operating, run init, firmware update etc. prepare configuration error	global status of module
Channel-Status-LED off green red / green alternating red		bicolor channel passive channel active over-range error error	status for each channel >5 % over nominal range see manual for detailed information

Sensor supply			
Parameter	Value typ.	min. / max.	Remarks
Output voltage UTI-6-SUP	$\pm 15\text{ V}, \pm 12\text{ V}, \pm 10\text{ V}, \pm 7.5\text{ V},$ $\pm 5\text{ V}, \pm 4\text{ V}, \pm 3.5\text{ V}, \pm 3.3\text{ V},$ $\pm 3\text{ V}, \pm 2.5\text{ V}$		referenced to GND; arbitrary for each channel
Output voltage UTI-6-TEDS	$+15\text{ V}, +12\text{ V}, +10\text{ V}, +7.5\text{ V},$ $+5\text{ V}, +4\text{ V}, +3.5\text{ V}, +3.3\text{ V},$ $+3\text{ V}, +2.5\text{ V}$		referenced to GND; arbitrary for each channel
Short-Circuit-Proof		unlimited duration	protection for module and each channel
Overvoltage protection		$\pm 50\text{ V}$	voltages are referenced to GND
Error of output voltage		$\pm 2\%$ $0.01\%/K \cdot \Delta T_a$	$\Delta T_a = T_a - 25^\circ\text{C} $; with T_a = ambient temperature
Output power per channel per module		0.5 W 0.4 W 2 W	bipolar supply with symmetric load unipolar supply or asymmetric load
Output impedance	0.6 Ω		

Measurement modes

Voltage measurement			
Parameter	Value typ.	min. / max.	Remarks
Input range	$\pm 60\text{ V}, \pm 50\text{ V}, \pm 25\text{ V}, \pm 10\text{ V}, \pm 5\text{ V},$ $\pm 2.5\text{ V}, \pm 1\text{ V to } \pm 25\text{ mV}$		
Max. Over Voltage	$\pm 200\text{ V}$		differential input voltage
Input impedance	1 M Ω 20 M Ω	$\pm 1\%$ $\pm 1\%$	measurement ranges $\geq \pm 5\text{ V}$ or device off measurement ranges $\leq \pm 2.5\text{ V}$
Gain error	0.008% $+ 0.0004\%/K \cdot \Delta T_a$	0.02% $+ 0.001\%/K \cdot \Delta T_a$	of reading $\Delta T_a = T_a - 25^\circ\text{C} $; with T_a = ambient temperature
Offset error	0.003% $+ 0.00006\%/K \cdot \Delta T_a$	0.02% or 10 μV $+ 0.001\%/K \cdot \Delta T_a$	of range whichever is greater $\Delta T_a = T_a - 25^\circ\text{C} $; with T_a = ambient temperature
Noise	75 μV_{rms} 1.8 μV_{rms} 1.2 μV_{rms} 0.8 μV_{rms}		sampling rate = 1 kHz; filter = AAF; resolution = 32 bit float; ranges: 60 V, ..., 5 V 2.5 V 1 V 500 mV, ..., 25 mV

Current measurement			
Parameter	Value typ.	min. / max.	Remarks
Input range	$\pm 20\text{ mA}$		$\pm 10\text{ mA}, \pm 5\text{ mA}, \pm 2\text{ mA}, \pm 1\text{ mA}$ on request
Overload	$\pm 100\text{ mA}$		
Input impedance	25 Ω	$\pm 1\%$	
Gain error		0.02% $+ 0.002\%/K \cdot \Delta T_a$	of the measured value $\Delta T_a = T_a - 25^\circ\text{C} $; with T_a = ambient temperature
Offset error		2 μA $+ 4\text{ nA}/K \cdot \Delta T_a$	of range $\Delta T_a = T_a - 25^\circ\text{C} $; with T_a = ambient temperature
Noise	30 nA_{rms}		bandwidth = 400 Hz; filter = AAF

Resistance measurement			
Parameter	Value typ.	min. / max.	Remarks
Input range	100 k Ω , 50 k Ω , 25 k Ω , 10 k Ω , ..., 100 Ω		
Overvoltage protection	± 30 V		
Gain error		0.02% + 0.002%/K $\cdot\Delta T_a$	of the measured value $\Delta T_a = T_a - 25^\circ\text{C} $; with T_a = ambient temperature
Offset error		0.01% + 0.003%/K $\cdot\Delta T_a$	of range $\Delta T_a = T_a - 25^\circ\text{C} $; with T_a = ambient temperature
SNR	-82 dB -100 dB -104 dB		bandwidth = 400 Hz; filter = AAF range = 100 k Ω ; signal: 1%..100% of range range = 10 k Ω ; signal: 1%..100% of range range = 1 k Ω

RTD measurement			
Parameter	Value typ.	min. / max.	Remarks
Temperature Sensors	Resistance Temperature Detectors (RTDs) PT100, PT1000		4-wire configuration
Input range	-200 $^\circ\text{C}$ to 850 $^\circ\text{C}$ -50 $^\circ\text{C}$ to 150 $^\circ\text{C}$		output format: 16 Bit INT or FLOAT output format: 16 Bit INT
Overvoltage protection	± 60 V		
Supply Current	0.88 mA 0.7 mA		PT100; $P_{dis} < 0.3$ mW PT1000; $P_{dis} < 1.9$ mW
Measurement error PT100, PT1000			
-200 $^\circ\text{C}$ to 0 $^\circ\text{C}$	0.001 K	0.05 K	
0 $^\circ\text{C}$ to 100 $^\circ\text{C}$	0.001 K	0.1 K	
100 $^\circ\text{C}$ to 300 $^\circ\text{C}$	0.002 K	0.18 K	
300 $^\circ\text{C}$ to 500 $^\circ\text{C}$	0.003 K	0.25 K	
500 $^\circ\text{C}$ to 850 $^\circ\text{C}$	0.006 K	0.4 K	
Noise, SNR	0.005 K _{pk-pk} -117 dB <1 LSB		100 ms sampling rate, average filter output format: Float; 850 $^\circ\text{C}$ output format: 16 Bit Integer; 850 $^\circ\text{C}$

Operating conditions

Operating conditions		
Parameter	Value	Remarks
Ingress protection class	IP65	dust- and splash water proof
Operating temperature range	-40 °C to +125 °C	internal condensation temporarily allowed
Pollution degree	2	
Dimensions (L x W x H)	153 x 40 x 53 mm	including mounting flanges and click mechanism
Weight	0.33 kg	

Power supply of the module			
Parameter	Value typ.	min. / max.	Remarks
Input supply voltage		7 V to 50 V DC 9.5 V to 50 V DC	after power up upon power up under conditions of IP65 (humidity): max. 35 V
Power consumption	1.8 W @ 12 V 6 W @ 12 V	<7.3 W	sensor supply not loaded sensor supply loaded
Power supply options	CAN/Power cable or via adjacent module		LEMO.0B, 5-pin module connector (click mechanism)

Max. number of modules for direct coupling (block size with click mechanism)		
Parameter	Value	Remarks
Max. number of modules	8	limited by termination of internal CAN-Bus backbone (click junction)

Pass through power limits for directly connected modules (click-mechanism)		
Parameter	Value	Remarks
Max. current	4 A	at 25 °C current rating of click connector
	$-20 \text{ mA/K} \cdot \Delta T_a$	derating with higher operating temperatures: T_a ; $\Delta T_a = T_a - 25 \text{ °C}$
Max. power	48 W at 12 V DC	equivalent pass through power at 25 °C typ. DC vehicle voltage AC/DC power adaptor and installations
	96 W at 24 V DC	
	24 W at 12 V DC 48 W at 24 V DC	at 125 °C

Available power for supply of additional modules via CAN-cable (LEMO.0B, "down stream")		
Parameter	Value	Remarks
Max. current	6.5 A	at 25 °C current rating of LEMO.0B connection (CAN-IN, CAN-OUT); assuming adequate wire cross section
	$-15 \text{ mA/K} \cdot \Delta T_a$	derating with higher operating temperatures: T_a ; $\Delta T_a = T_a - 25 \text{ °C}$
Max. power	78 W at 12 V DC 156 W at 24 V DC	equivalent pass through power at 25 °C typ. DC vehicle voltage AC/DC power adaptor and installations
	60 W at 12 V DC 120 W at 24 V DC	at +125 °C